

30 A - 600 V - short circuit rugged IGBT

Features

- Low on-voltage drop ($V_{CE(sat)}$)
- Low C_{res} / C_{ies} ratio (no cross conduction susceptibility)
- Short circuit withstand time 10 μ s

Applications

- High frequency inverters
- Motor drivers

Description

This IGBT utilizes the advanced PowerMESH™ process resulting in an excellent trade-off between switching performance and low on-state behavior.

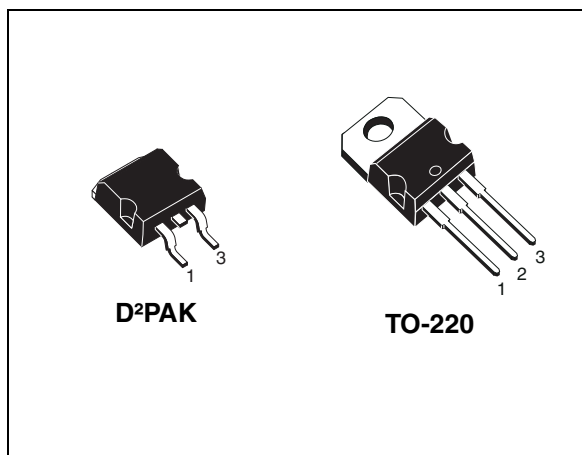

Figure 1. Internal schematic diagram

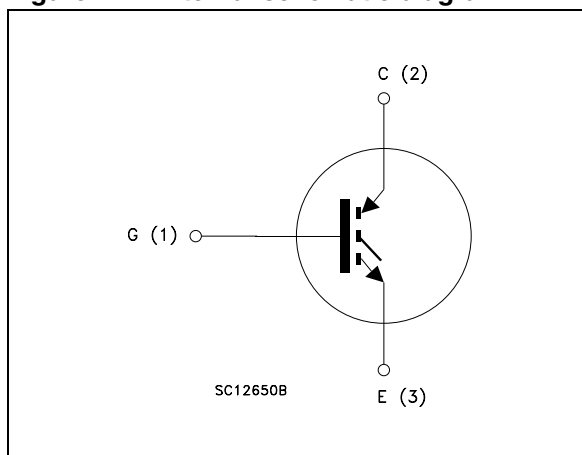

Table 1. Device summary

Order codes	Marking	Package	Packaging
STGB30NC60KT4	GB30NC60K	D ² PAK	Tape and reel
STGP30NC60K	GP30NC60K	TO-220	Tube

Contents

1	Electrical ratings	3
2	Electrical characteristics	4
	2.1 Electrical characteristics (curves)	6
3	Test circuit	9
4	Package mechanical data	10
5	Packaging mechanical data	13
6	Revision history	14

1 Electrical ratings

Table 2. Absolute maximum ratings

Symbol	Parameter	Value	Unit
V_{CES}	Collector-emitter voltage ($V_{GE} = 0$)	600	V
$I_C^{(1)}$	Collector current (continuous) at $T_C = 25^\circ\text{C}$	60	A
$I_C^{(1)}$	Collector current (continuous) at $T_C = 100^\circ\text{C}$	26	A
$I_{CL}^{(2)}$	Turn-off latching current	125	A
$I_{CP}^{(3)}$	Pulsed collector current	125	A
V_{GE}	Gate-emitter voltage	± 20	V
P_{TOT}	Total dissipation at $T_C = 25^\circ\text{C}$	185	W
t_{scw}	Short circuit withstand time, $V_{CE} = 0.5V_{(BR)CES}$ $T_j = 125^\circ\text{C}$, $R_G = 10 \Omega$, $V_{GE} = 12 \text{ V}$	10	μs
T_j	Operating junction temperature	- 55 to 150	$^\circ\text{C}$

1. Calculated according to the iterative formula:

$$I_c(T_c) = \frac{T_{J(MAX)} - T_c}{R_{thj-c} \times V_{CE(sat)(MAX)} \cdot (T_c, I_c)}$$

2. $V_{clamp} = 80\%(V_{CES})$, $T_j = 150^\circ\text{C}$, $R_G = 10 \Omega$, $V_{GE} = 15 \text{ V}$
 3. Pulse width limited by max. junction temperature allowed

Table 3. Thermal resistance

Symbol	Parameter	Value	Unit
$R_{thj-case}$	Thermal resistance junction-case max.	0.675	$^\circ\text{C/W}$
$R_{thj-amb}$	Thermal resistance junction-ambient max.	62.5	$^\circ\text{C/W}$

2 Electrical characteristics

($T_{CASE}=25^{\circ}\text{C}$ unless otherwise specified)

Table 4. Static

Symbol	Parameter	Test conditions	Min.	Typ.	Max.	Unit
$V_{(BR)CES}$	Collector-emitter breakdown voltage ($V_{GE}=0$)	$I_C=1\text{ mA}$	600			V
$V_{CE(SAT)}$	Collector-emitter saturation voltage	$V_{GE}=15\text{ V}, I_C=20\text{ A}$		2.1	2.7	V
		$V_{GE}=15\text{ V}, I_C=20\text{ A}, T_C=125^{\circ}\text{C}$		1.9		V
I_{CES}	Collector cut-off current ($V_{GE}=0$)	$V_{CE}=600\text{ V}$			150	μA
		$V_{CE}=600\text{ V}, T_C=125^{\circ}\text{C}$			1	mA
$V_{GE(th)}$	Gate threshold voltage	$V_{CE}=V_{GE}, I_C=250\text{ }\mu\text{A}$	4.5		6.5	V
I_{GES}	Gate-emitter cut-off current ($V_{CE}=0$)	$V_{GE}=\pm 20\text{ V}$			± 100	nA
$g_{fs}^{(1)}$	Forward transconductance	$V_{CE}=15\text{ V}, I_C=20\text{ A}$		15		S

1. Pulsed: Pulse duration = 300 μs , duty cycle 1.5%

Table 5. Dynamic

Symbol	Parameter	Test conditions	Min.	Typ.	Max.	Unit
C_{ies}	Input capacitance	$V_{CE}=25\text{ V}, f=1\text{ MHz}, V_{GE}=0$		2170		pF
C_{oes}	Output capacitance			230		pF
C_{res}	Reverse transfer capacitance			46		pF
Q_g	Total gate charge	$V_{CE}=480\text{ V}, I_C=20\text{ A},$		96		nC
Q_{ge}	Gate-emitter charge	$V_{GE}=15\text{ V}$		18		nC
Q_{gc}	Gate-collector charge	(see Figure 17)		46		nC

Table 6. Switching on/off (inductive load)

Symbol	Parameter	Test conditions	Min.	Typ.	Max.	Unit
$t_{d(on)}$ t_r $(di/dt)_{on}$	Turn-on delay time Current rise time Turn-on current slope	$V_{CC} = 480\text{ V}$, $I_C = 20\text{ A}$ $R_G = 10\ \Omega$, $V_{GE} = 15\text{ V}$ (see Figure 16)		29 12 1520		ns ns A/ μ s
$t_{d(on)}$ t_r $(di/dt)_{on}$	Turn-on delay time Current rise time Turn-on current slope	$V_{CC} = 480\text{ V}$, $I_C = 20\text{ A}$ $R_G = 10\ \Omega$, $V_{GE} = 15\text{ V}$, $T_C = 125^\circ\text{C}$ (see Figure 16)		27 14 1360		ns ns A/ μ s
$t_r(V_{off})$ $t_{d(off)}$ t_f	Off voltage rise time Turn-off delay time Current fall time	$V_{CC} = 480\text{ V}$, $I_C = 20\text{ A}$, $R_G = 10\ \Omega$, $V_{GE} = 15\text{ V}$ (see Figure 16)		36 120 85		ns ns ns
$t_r(V_{off})$ $t_{d(off)}$ t_f	Off voltage rise time Turn-off delay time Current fall time	$V_{CC} = 480\text{ V}$, $I_C = 20\text{ A}$, $R_G = 10\ \Omega$, $V_{GE} = 15\text{ V}$ $T_C = 125^\circ\text{C}$ (see Figure 16)		75 160 130		ns ns ns

Table 7. Switching energy (inductive load)

Symbol	Parameter	Test conditions	Min	Typ.	Max	Unit
E_{on} $E_{off}^{(1)}$ E_{ts}	Turn-on switching losses Turn-off switching losses Total switching losses	$V_{CC} = 480\text{ V}$, $I_C = 20\text{ A}$ $R_G = 10\ \Omega$, $V_{GE} = 15\text{ V}$, (see Figure 16)		350 435 785		μ J μ J μ J
E_{on} $E_{off}^{(1)}$ E_{ts}	Turn-on switching losses Turn-off switching losses Total switching losses	$V_{CC} = 480\text{ V}$, $I_C = 20\text{ A}$ $R_G = 10\ \Omega$, $V_{GE} = 15\text{ V}$, $T_C = 125^\circ\text{C}$ (see Figure 16)		590 845 1435		μ J μ J μ J

1. Turn-off losses include also the tail of the collector current.

2.1 Electrical characteristics (curves)

Figure 2. Output characteristics

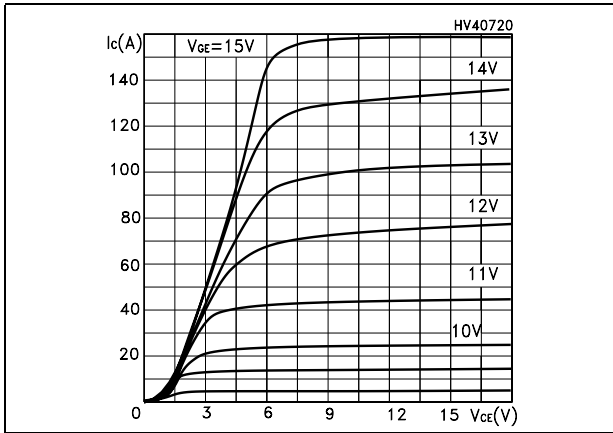

Figure 3. Transfer characteristics

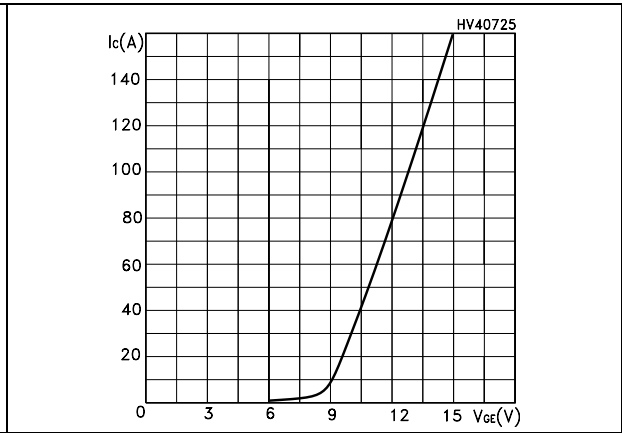

Figure 4. Transconductance

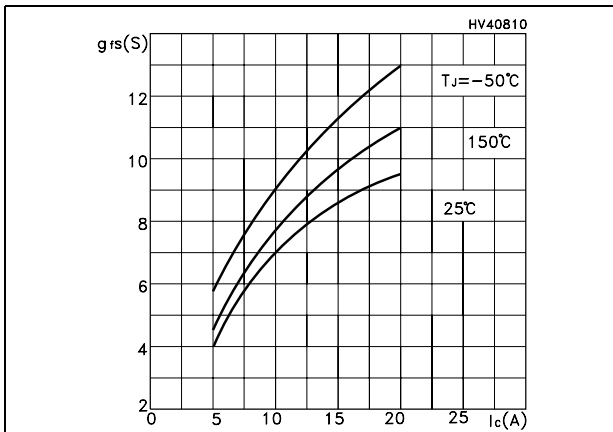

Figure 5. Collector-emitter on voltage vs temperature

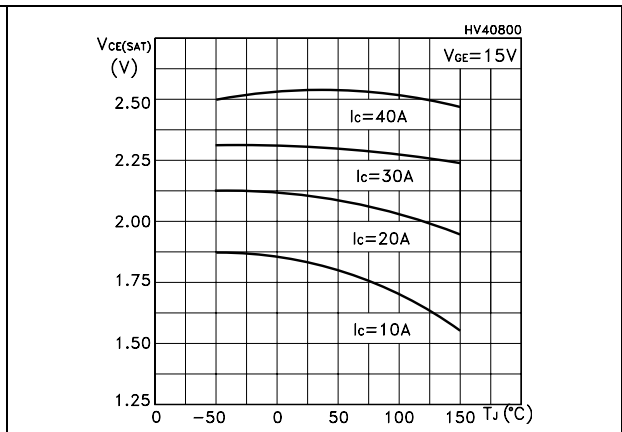

Figure 6. Gate charge vs gate-source voltage

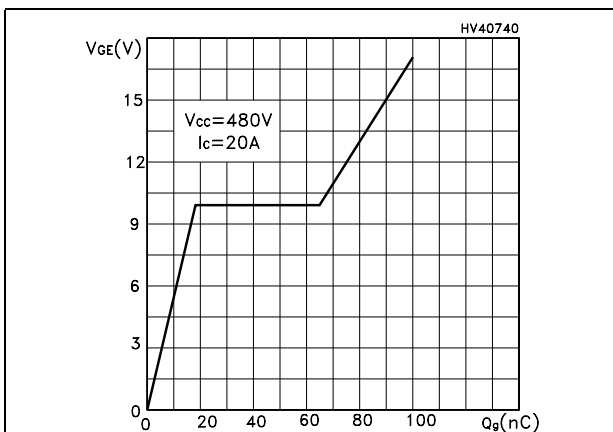

Figure 7. Capacitance variations

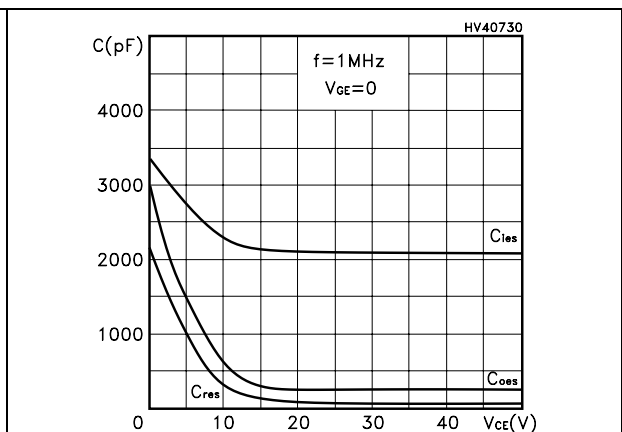

Figure 8. Normalized gate threshold voltage vs temperature

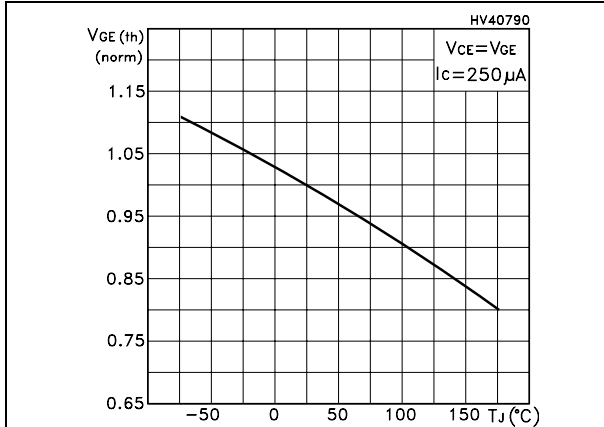

Figure 9. Collector-emitter on voltage vs collector current

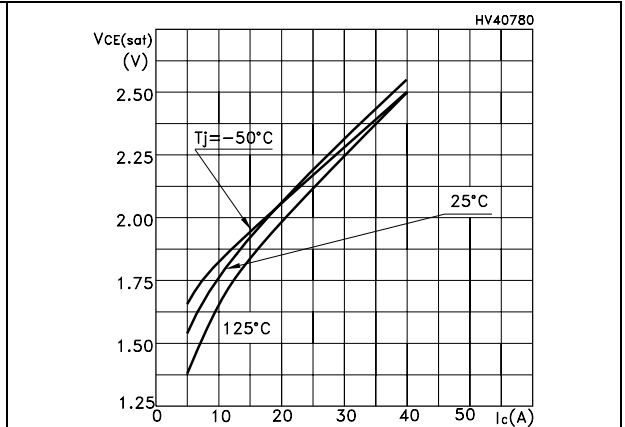

Figure 10. Normalized breakdown voltage vs temperature

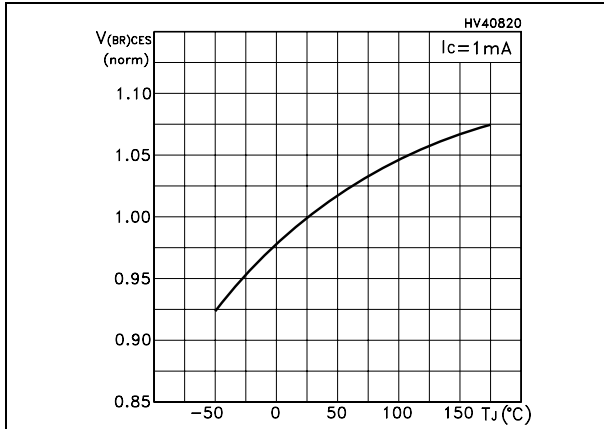

Figure 11. Switching losses vs temperature

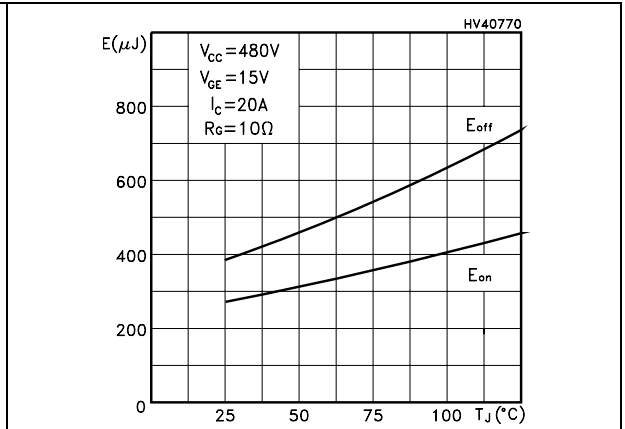

Figure 12. Switching losses vs gate resistance

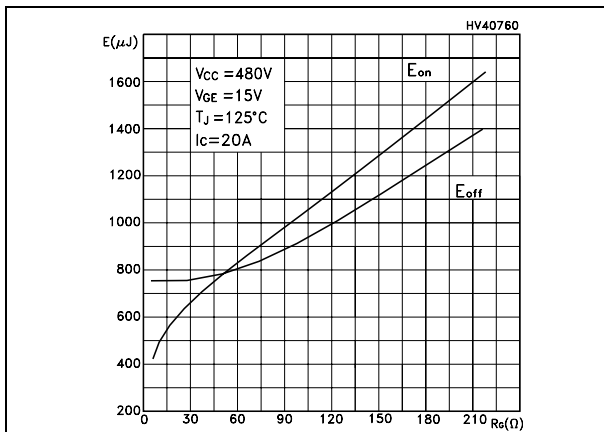

Figure 13. Switching losses vs collector current

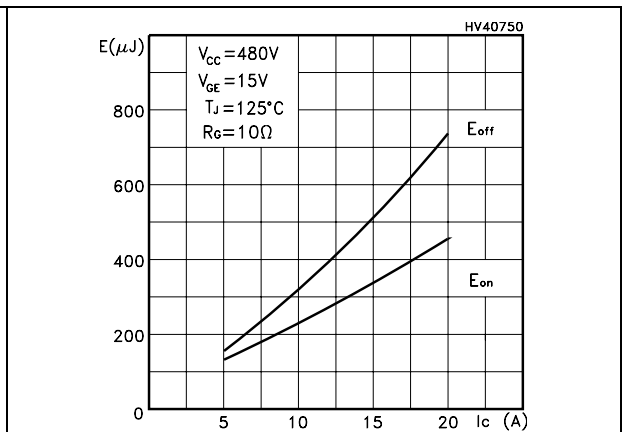

Figure 14. Thermal Impedance

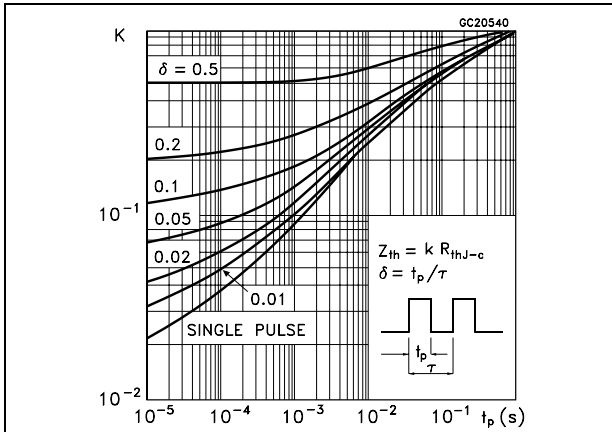
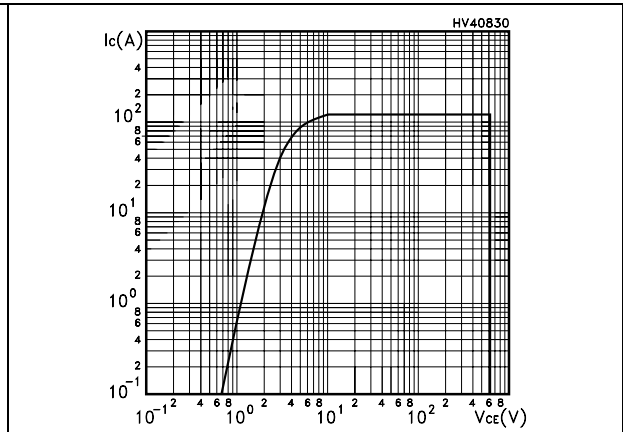

Figure 15. Turn-off SOA



3 Test circuit

Figure 16. Test circuit for inductive load switching

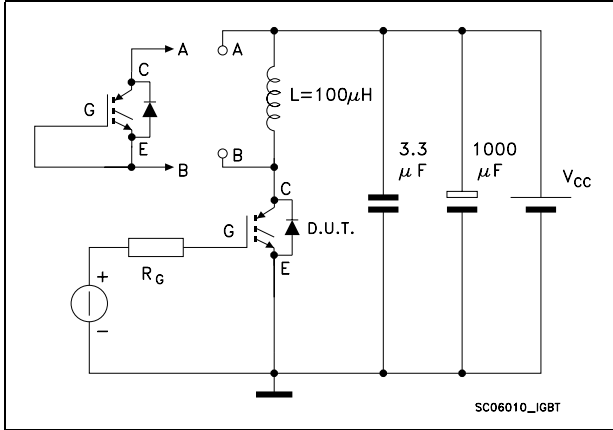

Figure 17. Gate charge test circuit

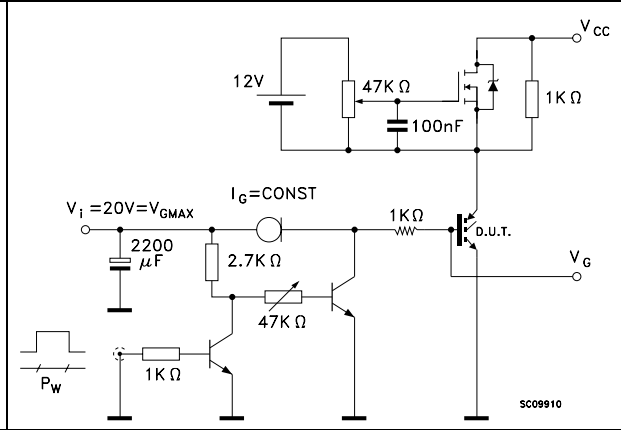
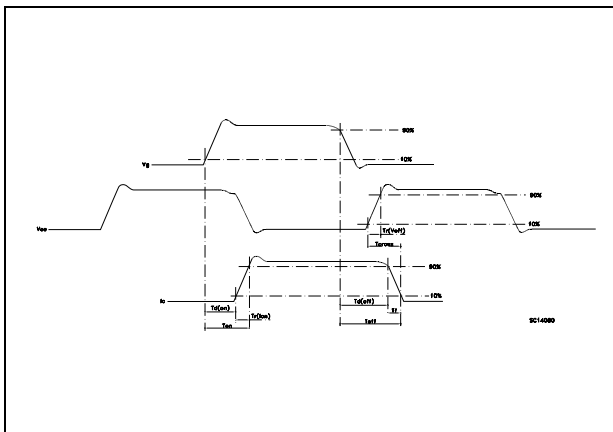

Figure 18. Switching waveforms



4 Package mechanical data

In order to meet environmental requirements, ST offers these devices in ECOPACK® packages. These packages have a lead-free second level interconnect. The category of second level interconnect is marked on the package and on the inner box label, in compliance with JEDEC Standard JESD97. The maximum ratings related to soldering conditions are also marked on the inner box label. ECOPACK is an ST trademark. ECOPACK specifications are available at: www.st.com

TO-220 mechanical data

Dim	mm			inch		
	Min	Typ	Max	Min	Typ	Max
A	4.40		4.60	0.173		0.181
b	0.61		0.88	0.024		0.034
b1	1.14		1.70	0.044		0.066
c	0.48		0.70	0.019		0.027
D	15.25		15.75	0.6		0.62
D1		1.27			0.050	
E	10		10.40	0.393		0.409
e	2.40		2.70	0.094		0.106
e1	4.95		5.15	0.194		0.202
F	1.23		1.32	0.048		0.051
H1	6.20		6.60	0.244		0.256
J1	2.40		2.72	0.094		0.107
L	13		14	0.511		0.551
L1	3.50		3.93	0.137		0.154
L20		16.40			0.645	
L30		28.90			1.137	
∅P	3.75		3.85	0.147		0.151
Q	2.65		2.95	0.104		0.116

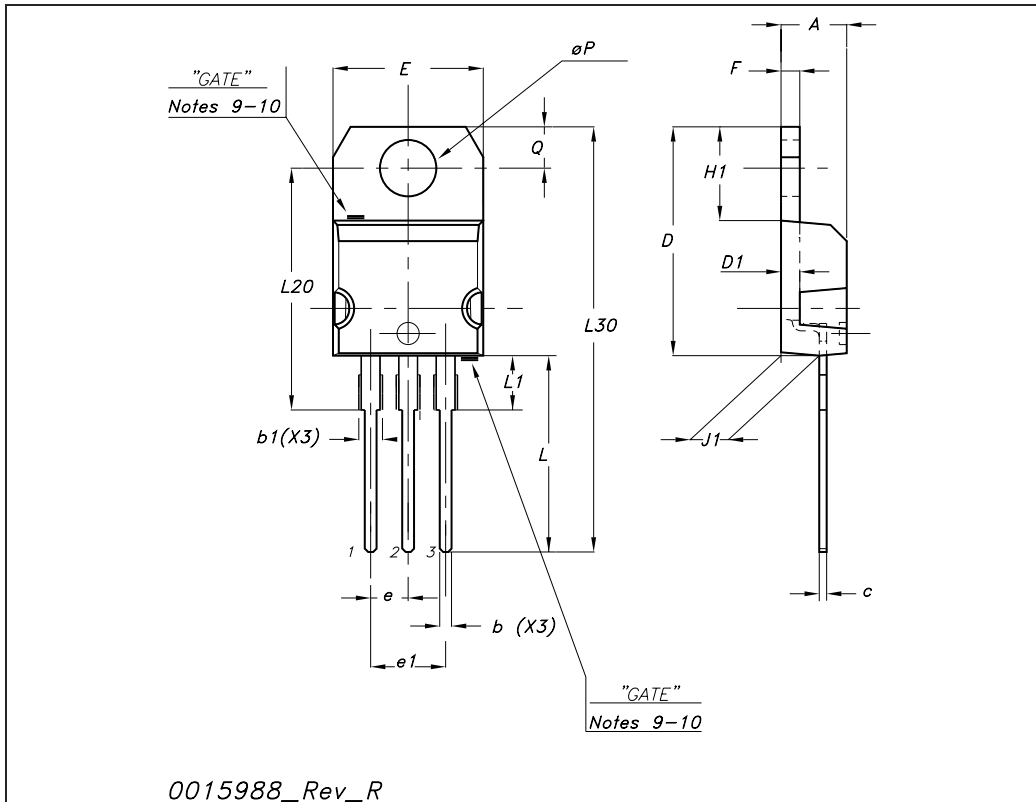

D²PAK (TO-263) mechanical data

Dim	mm			inch		
	Min	Typ	Max	Min	Typ	Max
A	4.40		4.60	0.173		0.181
A1	0.03		0.23	0.001		0.009
b	0.70		0.93	0.027		0.037
b2	1.14		1.70	0.045		0.067
c	0.45		0.60	0.017		0.024
c2	1.23		1.36	0.048		0.053
D	8.95		9.35	0.352		0.368
D1	7.50			0.295		
E	10		10.40	0.394		0.409
E1	8.50			0.334		
e		2.54			0.1	
e1	4.88		5.28	0.192		0.208
H	15		15.85	0.590		0.624
J1	2.49		2.69	0.099		0.106
L	2.29		2.79	0.090		0.110
L1	1.27		1.40	0.05		0.055
L2	1.30		1.75	0.051		0.069
R		0.4			0.016	
V2	0°		8°	0°		8°

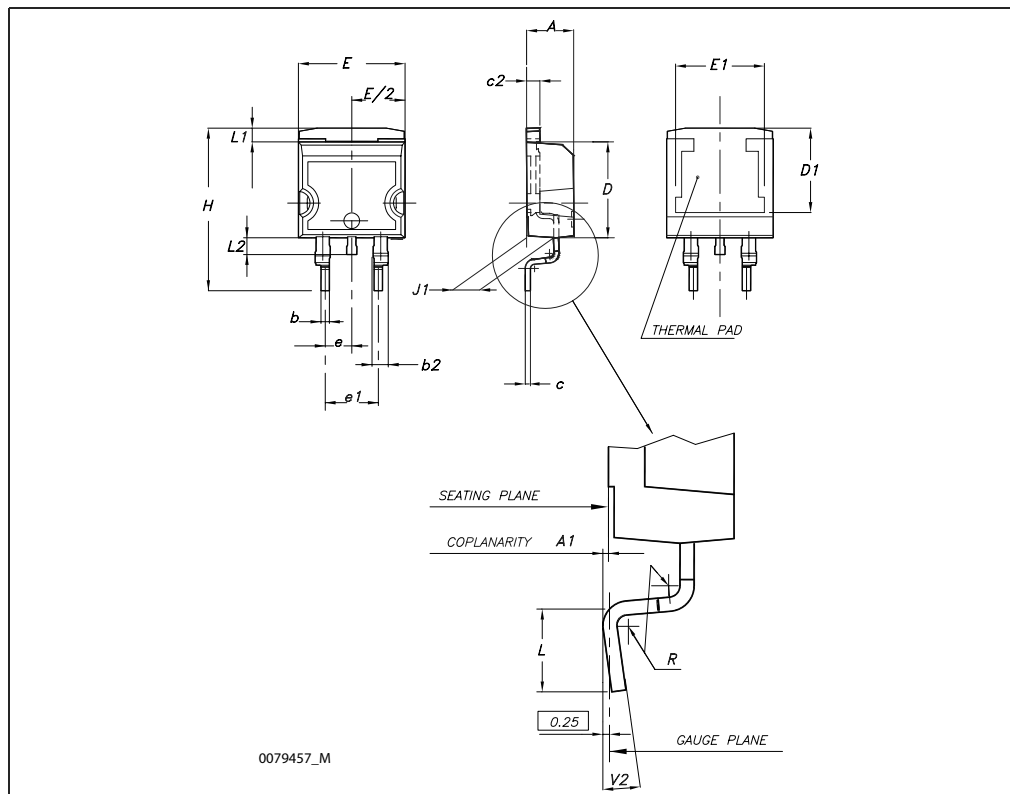

5 Packaging mechanical data

D²PAK FOOTPRINT

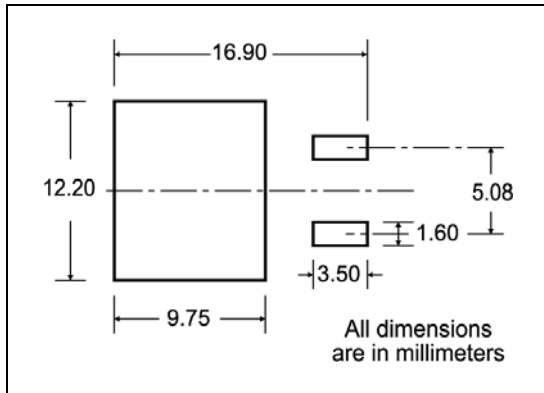

TAPE AND REEL SHIPMENT

TAPE MECHANICAL DATA

DIM.	mm		inch	
	MIN.	MAX.	MIN.	MAX.
A0	10.5	10.7	0.413	0.421
B0	15.7	15.9	0.618	0.626
D	1.5	1.6	0.059	0.063
D1	1.59	1.61	0.062	0.063
E	1.65	1.85	0.065	0.073
F	11.4	11.6	0.449	0.456
K0	4.8	5.0	0.189	0.197
P0	3.9	4.1	0.153	0.161
P1	11.9	12.1	0.468	0.476
P2	1.9	2.1	0.075	0.082
R	50		1.574	
T	0.25	0.35	0.0098	0.0137
W	23.7	24.3	0.933	0.956

REEL MECHANICAL DATA

DIM.	mm		inch	
	MIN.	MAX.	MIN.	MAX.
A		330		12.992
B	1.5		0.059	
C	12.8	13.2	0.504	0.520
D	20.2		0.795	
G	24.4	26.4	0.960	1.039
N	100		3.937	
T		30.4		1.197

BASE QTY	BULK QTY
1000	1000

TRL

FEED DIRECTION

User Direction of Feed

Bending radius

* on sales type

6 Revision history

Table 8. Document revision history

Date	Revision	Changes
12-Feb-2008	1	Initial release
07-Mar-2008	2	Updated mechanical data for both packages

Please Read Carefully:

Information in this document is provided solely in connection with ST products. STMicroelectronics NV and its subsidiaries ("ST") reserve the right to make changes, corrections, modifications or improvements, to this document, and the products and services described herein at any time, without notice.

All ST products are sold pursuant to ST's terms and conditions of sale.

Purchasers are solely responsible for the choice, selection and use of the ST products and services described herein, and ST assumes no liability whatsoever relating to the choice, selection or use of the ST products and services described herein.

No license, express or implied, by estoppel or otherwise, to any intellectual property rights is granted under this document. If any part of this document refers to any third party products or services it shall not be deemed a license grant by ST for the use of such third party products or services, or any intellectual property contained therein or considered as a warranty covering the use in any manner whatsoever of such third party products or services or any intellectual property contained therein.

UNLESS OTHERWISE SET FORTH IN ST'S TERMS AND CONDITIONS OF SALE ST DISCLAIMS ANY EXPRESS OR IMPLIED WARRANTY WITH RESPECT TO THE USE AND/OR SALE OF ST PRODUCTS INCLUDING WITHOUT LIMITATION IMPLIED WARRANTIES OF MERCHANTABILITY, FITNESS FOR A PARTICULAR PURPOSE (AND THEIR EQUIVALENTS UNDER THE LAWS OF ANY JURISDICTION), OR INFRINGEMENT OF ANY PATENT, COPYRIGHT OR OTHER INTELLECTUAL PROPERTY RIGHT.

UNLESS EXPRESSLY APPROVED IN WRITING BY AN AUTHORIZED ST REPRESENTATIVE, ST PRODUCTS ARE NOT RECOMMENDED, AUTHORIZED OR WARRANTED FOR USE IN MILITARY, AIR CRAFT, SPACE, LIFE SAVING, OR LIFE SUSTAINING APPLICATIONS, NOR IN PRODUCTS OR SYSTEMS WHERE FAILURE OR MALFUNCTION MAY RESULT IN PERSONAL INJURY, DEATH, OR SEVERE PROPERTY OR ENVIRONMENTAL DAMAGE. ST PRODUCTS WHICH ARE NOT SPECIFIED AS "AUTOMOTIVE GRADE" MAY ONLY BE USED IN AUTOMOTIVE APPLICATIONS AT USER'S OWN RISK.

Resale of ST products with provisions different from the statements and/or technical features set forth in this document shall immediately void any warranty granted by ST for the ST product or service described herein and shall not create or extend in any manner whatsoever, any liability of ST.

ST and the ST logo are trademarks or registered trademarks of ST in various countries.

Information in this document supersedes and replaces all information previously supplied.

The ST logo is a registered trademark of STMicroelectronics. All other names are the property of their respective owners.

© 2008 STMicroelectronics - All rights reserved

STMicroelectronics group of companies

Australia - Belgium - Brazil - Canada - China - Czech Republic - Finland - France - Germany - Hong Kong - India - Israel - Italy - Japan - Malaysia - Malta - Morocco - Singapore - Spain - Sweden - Switzerland - United Kingdom - United States of America

www.st.com